

# **Operating and Maintenance Instructions**

## **Fischer Plate Heat Exchanger**



**ATTENTION**

**READ THESE OPERATING INSTRUCTIONS CAREFULLY BEFORE CONNECTING AND COMMISSIONING!**

**HEED ALL SAFETY INSTRUCTIONS!**

**OBSERVE IN-HOUSE OPERATING, WORK AND SAFETY REGULATIONS!**

**ALSO, COMPLY WITH NATIONAL REQUIREMENTS!**

**UNAUTHORISED CONVERSIONS AND CHANGES TO THE PRODUCT ARE NOT ALLOWED FOR SAFETY REASONS!**

**FAILURE TO HEED THE INFORMATION MAY RESULT IN**

- **DANGER TO PEOPLE**
- **DAMAGE TO THE EQUIPMENT!**

**LEGEND:**

**Failure to follow these instructions can endanger people.**



**Electrical voltage warning (electric shock)**



**Particular danger from corrosive substances**

**Use protective equipment!**

**ATTENTION**

**Safety instructions which, if disregarded, can pose a danger to machinery and its operation.**



## Table of Contents

1. GENERAL
2. SAFETY INSTRUCTIONS
3. TRANSPORT
4. STORAGE
5. CONNECTION OF PIPELINES
6. COMMISSIONING / OPERATION
  - 6.1 Preparation
  - 6.2 Check before using for the first time
  - 6.3 Filling
  - 6.4 After long term storage
  - 6.5 Bleeding
  - 6.6 Permissible pressure
  - 6.7 Retightening
  - 6.8 Operation
  - 6.9 Decommissioning
7. DISMANTLING
8. STORAGE
9. RETIGHTENING THE PLATE HEAT EXCHANGER
  - 9.1 Retightening after initial commissioning or after gasket replacement
10. MANUAL CLEANING
  - 10.1 Close the pipes from the pressure plate
  - 10.2 Remove the heat exchanger plate
  - 10.3 Clean the heat exchanger plate
11. CLEANING WITH THE CIP CLEANING SYSTEM
  - 11.1 One-step plan
  - 11.2 Two-step plan
12. MAINTENANCE / INSPECTION
13. GASKET REPLACEMENT
  - 13.1 Glued in rubber gaskets
  - 13.2 "PIN CLIP" rubber gaskets
  - 13.3 "PRESS IN" rubber gaskets
  - 13.4 CAF gaskets
  - 13.5 Glued in silicone gaskets
14. ERROR / CAUSE / REMEDY
15. DRAWING, SPARE PARTS LIST

## 1. GENERAL

### **ATTENTION**

- **These operating instructions contain important information for the**
  - **safe**
  - **appropriate**
  - **economic****operation of Fischer plate heat exchangers.**
  
- **Please read the instructions**
  - **completely and**
  - **carefully****and follow the instructions.**



- **Failure to heed the information may result in**
  - **danger to people**
  - **damage to the system.**

These operating instructions do not take into account all possible coincidences and events that can occur during assembly, operation and maintenance.

If the required information is not found in these operating instructions, please consult the manufacturer.

If anything is unclear, the manufacturer should also be consulted.

- Observe the operating instructions for any maintenance, inspection or repair

### **Fischer plate heat exchangers**

- are specially developed for the **food sector** and **industrial applications** and as an apparatus are a part/component of complete systems. It is, therefore, important that the systems correspond to state-of-the-art standards.
- are **made with maximum care**
- are subject to **ongoing quality control**
- have a very **high efficiency**
- are especially **easy to maintain**

A wear allowance of 0 mm was taken into account in the calculation.

## 2. SAFETY INSTRUCTIONS

### ATTENTION

- **The following activities may only be carried out by qualified and trained employees:**

- Assembly
- Connection
- Commissioning
- Operation
- Inspection
- Maintenance



- **Installation:**

- The installation site must have adequate strength
- Ensure that the plant is sufficiently stable
- is horizontal
- There is sufficient space for service work (at least 90 cm above and to the side of the plate heat exchanger)
- Plate heat exchangers have a high centre of gravity - there is a risk of tipping over.



- **Connection:**

**Pipelines:**

- Forces or moments must not act on the connections of the plant/plate heat exchanger (e.g. due to thermal expansion) - as there is a risk of liquid leakage!
- Hazardous areas with hot media must be secured against contact.
- Thoroughly clean (rinse) the pipes before connecting them.



**Electrical:**

- Connection only by authorised and qualified employees
- only when de-energised (**risk of death** by electric shock)
- adhere to suitable protective measures (e.g. protective earthing, zeroing)
- Observe the connection conditions of the local energy supply company

- **Commissioning:**

**ATTENTION**

- Only by authorised, trained and instructed personnel
- Check
  - plate heat exchanger is installed in a stable and horizontal position
  - correct connection of
    - supply lines
    - outlets
  - all covers have been installed and the tightness of the gaskets!
- Note the direction of rotation of the pumps (avoidance of vibrations)

- **Operation:**

**ATTENTION**

- Please note:
  - National regulations
  - Operating and safety regulations
  - Internal company regulations
  - Work regulations
- Never exceed the specified technical data
- Only use the system as intended

**ATTENTION**

**The plate heat exchanger must not be opened during operation and when it is hot!**



- **Protect the following from contact:**
  - Hot system parts (surface temperature can reach 51°C and more!)
  - Hot escaping liquid in the event of a fault (e.g. by a protective plate / protective screen)



- **Never remove the following during operation:**
  - Covers of hot parts
  - Other covers and safety devices

- **Checks:**

**ATTENTION**

**Continuously check**

- the gaskets to detect leaks in good time



- **Maintenance:**

- Only by authorised and trained personnel
- Only at shut-down condition protected against re-start
- Only without pressure in the system
- Empty the pipes before maintenance
- Let hot parts cool down
- Observe maintenance and inspection instructions
- Only use original spare parts
- Never use force
- Always wear suitable protective clothing when working on the plate heat exchanger or in the area of the plate heat exchanger! (Face protection, safety glasses, possibly helmet, gloves, appropriate work clothes according to the occupational safety requirements, etc.)



- **Use of dangerous substances:**

**Acids** and **alkalis** are used for cleaning and gasket replacement. Please note when handling acids and alkalis

- Take all necessary safety precautions
- Observe legal regulations
- Observe internal company regulations
- Use rubber gloves, apron & goggles
- Dispose of the acids and alkalis according to local regulations

The following substances can be used for degreasing when replacing gaskets:

- benzine
- adhesive cleaner
- acetone
- toluene
- ketone
- spirit

Use a suitable respirator when using these agents. Please also note the flammability of these substances.



### 3. TRANSPORT

- Make sure that transportation is carried out properly
- Avoid shocks or bumps
- The plate heat exchanger must be secured against slipping when transported on a truck - the plate heat exchanger may only be transported in a horizontal position
- Use the designated transport holes
- Plate heat exchangers have a high centre of gravity - there is a risk of tipping over.
- The equipment must be clamped during transport (clamping bolts must be tightened)

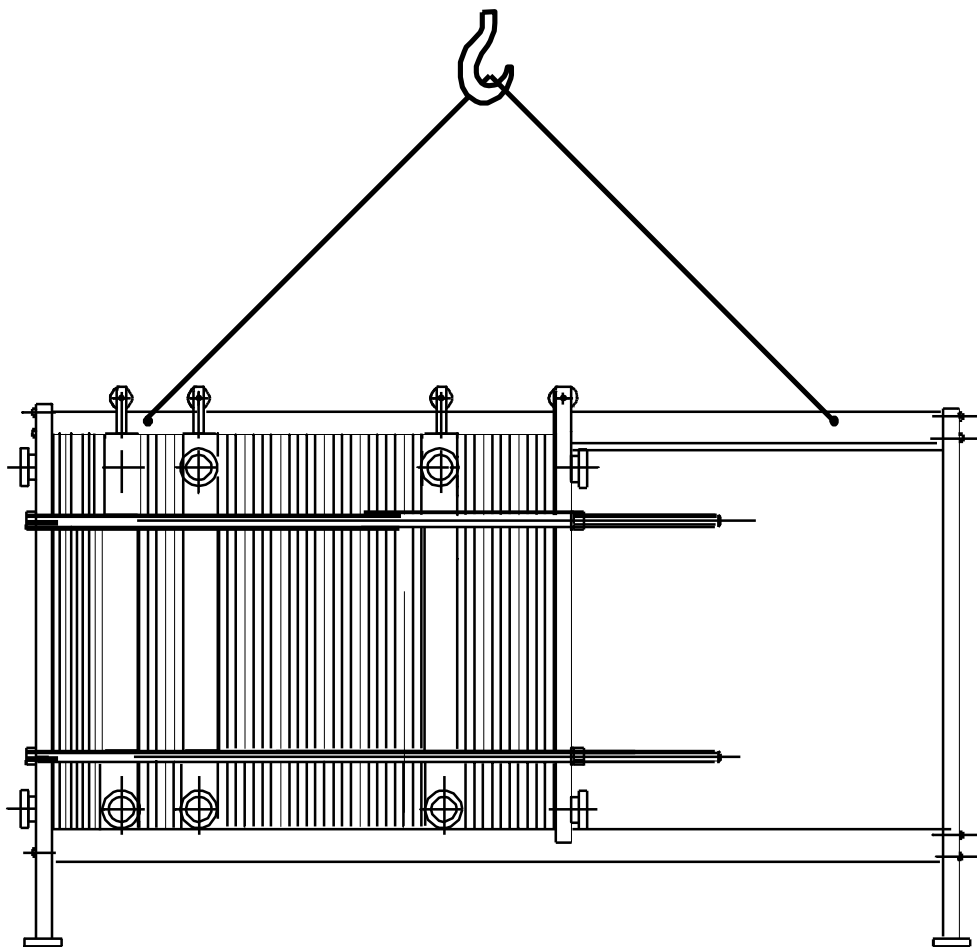

### 4. STORAGE

- Empty the plate heat exchanger when not in use for a long time
- Disassemble and clean the heat exchanger
- Reassemble the heat exchanger (plates and gaskets must be dry)
- Tighten the heat exchanger only slightly
- Close the connection openings



## 5. CONNECTION OF PIPELINES

### **ATTENTION**

- Use nominal pipe sizes at least as large as that of the heat exchanger
- Use adapters with an extension bracket when increasing the nominal size
- Run the piping at a distance  $\geq 90\text{cm}$  from the heat exchanger
- Fix the pipes directly at the connections
- Neither forces nor moments from the pipes may act on the heat exchanger (e.g. in the case of thermal expansion) - provide suitable compensation
- Use flexible pipes (lengthways) for connection to moving parts of the heat exchanger (e.g. rotating pipe bends or compensation pieces)
- Connect the pipes according to the label (ON / OFF)
- Use an overpressure safety device at the inlet (possibly outlet too)
- When cleaning in place (CIP), suitable pipes and fittings must be used
- Use a cover or an insulating jacket (option) for dangerous or particularly hot media



**If forces or moments of the pipeline act on the heat exchanger, leaks can occur. Escaping hot media can be life-threatening!**



## 6. COMMISSIONING / OPERATION

### 6.1 Preparation

#### **ATTENTION**

- Clean pipelines, containers etc. carefully and remove all foreign parts (e.g. welding beads, chips, scale, packaging material)

#### **ATTENTION**

Before the first product run, clean the heat exchanger sufficiently.  
Also, clean after regasketing or fitting new heat exchanger plates!

### 6.2 Check before using for the first time

- The installation site must have adequate strength
- There is sufficient space for service work (at least 90 cm above and to the side of the plate heat exchanger)
- The mechanical fastening is according to regulations
- The pipe connection is correct
- The clamping dimensions (see type plate)
- All protective devices are connected
- All covers have been installed.
- if necessary, retighten the clamping bolts to the required clamping dimension (see enclosed circuit diagram)

### 6.3 Filling

**The first test run of the plate heat exchanger must be carried out with clear water - never with a product!**

- Start the pump with the valve closed
- Slowly open the control valve after the pump
- The pressure and temperature have to rise slowly
- Avoid pressure surges

Leaks during initial commissioning can occur up until

- operating pressure is reached
- operating temperature is reached
- all sections are under pressure

### 6.4 After long term storage

If the plate heat exchanger has been stored for a long time (from a few weeks), leaks can occur.

In this case, retighten the plate heat exchanger (see point 9).

### 6.5 Bleeding

As soon as the operating temperature and pressure have been reached:  
Bleed the plate heat exchanger

- Air in the plate heat exchanger is driven out by liquid flow.

### 6.6 Permissible pressure



#### ATTENTION

The type plate shows:

- **Max. permissible pressure (working pressure / operating pressure):**  
Max. pressure during operation
- **PRESSURE CHECK:**  
Max. pressure at which the heat exchanger can be checked

Prerequisite for specified pressure values:

- all sections under pressure

If there are large pressure differences in the individual sections, leaks can occur.

### 6.7 Retightening

In the first few weeks of operation, the gaskets adapt exactly to the contours of the heat exchanger plates.

**Regularly check the tightness of the heat exchanger and retighten the plates slightly.**

Follow the instructions under point 9.



**The tightness of the heat exchanger must be checked continuously!  
Leaking media can be life-threatening!**

## 6.8 Operation

**ATTENTION**



- **Avoid:**
  - unnecessary switching on and off
  - pressure surges
  - vibrations
  - shocks
- **Do not exceed:**
  - the permissible density of the medium
  - the max. permissible working pressure (operating pressure)
  - the permissible medium temperatures
- **Regularly check**
  - the temperature
  - for pressure drops (increasing pressure drop -> plates contaminated)
  - the tightness of the gaskets
  - Note the use of "splash protection devices"



Fischer plate heat exchangers are manufactured with the latest know-how and the greatest care and are subjected to extensive quality assurance. Nevertheless, a defect in a heat exchanger plate or gasket can never be ruled out 100%. It is, therefore, necessary to provide appropriate safety devices that prevent or prevent the media from mixing or escaping (e.g. pressure monitoring, positive pressure drop, conductivity measurement, splash guard or similar). Most safety devices can also be retrofitted for older devices and systems using the latest technology. Fischer GmbH is at your disposal for advice at any time.

The manufacturer is not liable for consequential damage!

## 6.9 Decommissioning

- Slowly close the valve supply line
- Switch off the pump
- Artificially cool or allow to cool

## 7. DISMANTLING



- Pumps must be switched off
- Heat exchangers and lines must be depressurised
- The heat exchanger and medium must have cooled down
- Close the shut-off devices of supply and discharge lines
- Empty the heat exchanger
  - Collect the liquid
  - Dispose of the medium in accordance with the law
- Close the pipes
- When opening, make sure that no heat exchange plates fall out!



### **With dangerous media:**

- Exclude any danger to people and the environment
- Comply with the legal requirements
- Wear protective clothing
- Clean and/or neutralise the heat exchanger

## 8. STORAGE

- **Dismantling**
  - as described under point 7
- **Storage**
  - Empty the heat exchanger completely
  - Let the heat exchanger dry out
  - Close:
    - inlet nozzles
    - outlet nozzles
  - Keep the heat exchanger dry

## 9. RETIGHTENING THE PLATE HEAT EXCHANGER

### ATTENTION

**The retightening process may only be carried out on the completely unpressurised plate heat exchanger!**

**All pressures in all sections must be released before the clamping process!**

Please make sure that the pipes do not generate any forces or moments! - Disconnect them!

The clamping dimension is the dimension between the frame and the movable pressure plate (10) (measured from the side of the plate pack). I.e. the dimension of the plate pack.

Always pay attention to the values of the current arrangement drawing. The range for the clamping dimension lies between the initial (max.dimension) and final clamping dimension (min.dimension).

This dimension should not be lower than the specified final clamping dimension! If medium escapes between the individual plates of the heat exchanger, it may be necessary to retighten the heat exchanger.

#### Retightening process:

- Remove the locknut (12a)
- Retighten all nuts for clamping bolts (12) clockwise
- Observe the following
  - Tighten the nuts for the clamping bolts (12) crosswise
  - Parallelism between frame plate (4) and movable pressure plate (10)
  - Clamping dimension according to the type plate/circuit diagram
- Fix the clamping bolt nuts (12) by screwing on the locking nuts (12a)

If the minimum clamping dimension according to the type plate/circuit diagram has been reached and the heat exchanger is still leaking, the gaskets must be replaced. Please note in accordance with point 14 whether there is any other error.

### 9.1 *Retightening after initial commissioning or after gasket replacement*

In the first few weeks of operation, the gaskets adapt exactly to the contours of the heat exchanger plates.

Therefore, the heat exchanger should be re-tightened continuously.



**Check the tightness of the heat exchanger regularly.**

### 9.2 **NEW!**

A nut made of material 2.0966 is used for the new version of the clamping bolts.

The use of grease is not necessary with this version.

The locking nut (12a) is therefore also omitted with this version.

## 10. MANUAL CLEANING

### 10.1 Close the pipes-valves and disconnect pipework from the pressure plate

Disassemble the pipes on the pressure and connection plate as described under point 7

### 10.2 Remove the heat exchanger plate

- Remove the locknuts (12a)
- Unscrew the clamping bolt nuts (12) from the clamping bolts (1)
- Remove the clamping bolt washers (13)
- Remove the clamping bolts (1)
- Push the movable pressure plate (10) away from the plate pack
- Tilt out the first heat exchanger plates downwards 20 - 30cm lengthways [1]
- Tilt the plate out sideways at an angle of 30 - 45° [2]

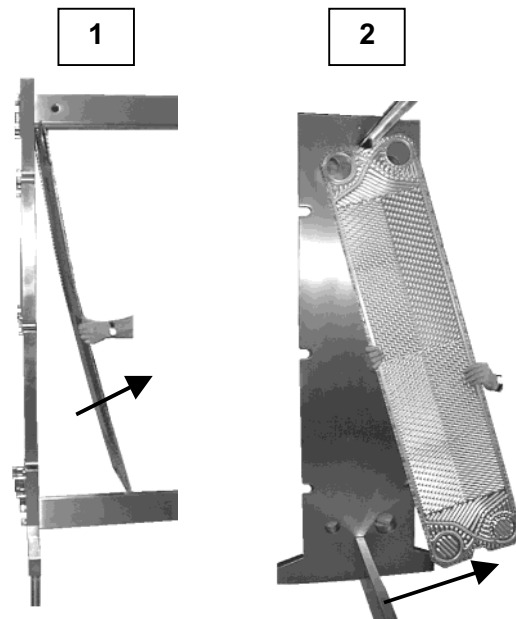

- Now remove the plate from the frame
- Remove plate by plate in this way
- Please note the order and installation position of the plates - these must be installed again after cleaning

### 10.3 Clean the heat exchanger plate

- Rinse the individual plates with a suitable cleaning agent (must not attack the gasket or plates). *You can obtain information about suitable cleaning agents from the heat exchanger manufacturer.*
- Clean the plates with a soft brush
- **Gasket should not be exchanged:**
  - Avoid placing the plate in cleaning solution
- **Gasket should be exchanged:**
  - Place the plate in hot cleaning solution (approx. 100°C)
- For thick layers of scale:
  - Place the plate in hot cleaning solution (approx. 100°C)

**Do NOT use:**

- Steel wire brush
- Metal scrapers or the like

### 10.4 Assembly

- Put the cleaned plates back in. Observe:
  - the original order and position of the individual plates (according to numbering and circuit diagram)
  - gaskets have been inserted and in order
- Hook in the individual plates (swivel in sideways at an angle of 30 - 45°)
- Push the movable pressure plate (10) to the plate pack

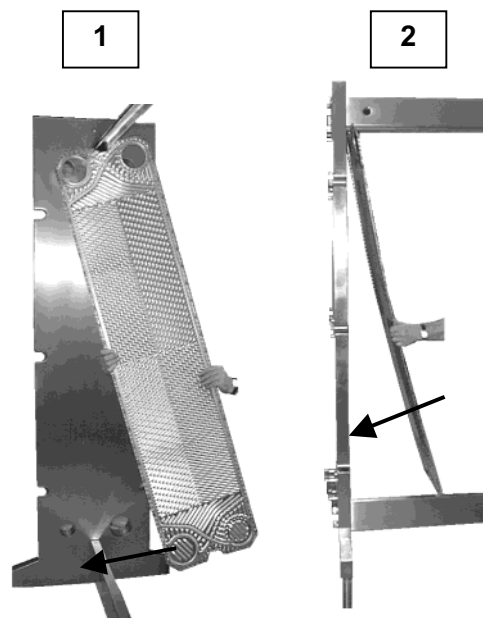

- Put the clamping bolts (1) back into the holes provided or hang them in the side slots
- Place the clamping bolt washers (13) onto the clamping bolts (1)





- Tighten the plate pack with the clamping bolt nuts (12)
  - evenly
  - crosswise
  - Observe the parallelism between the pressure plate (10) and the frame plate (4)
- Observe the clamping dimension on the type plate/circuit diagram
- Fix the clamping bolt nuts (12) by screwing on the locking nuts (12a)
- Reconnect the pipes
- Commission the heat exchanger according to point 6
- ATTENTION: For clamping bolt-NEW with nut material 2.0966 (color: brass yellow), the locking nut (12a) is not required. Grease not required for nut material 2.0966!
- If you are uncertain, contact the manufacturer!



## 11. CLEANING WITH THE CIP CLEANING SYSTEM

Plate heat exchangers in the food and beverage industry require chemical cleaning at certain intervals. With a Fischer CIP cleaning system, these cleaning operations can be carried out very easily and quickly.

With correct intensity and duration:

- Plates are shiny metallic
- All coatings are removed

Shortly after commissioning the cleaning system (first to fourth cleaning)

- Open the plate heat exchanger (point 10)
- Check all plates for cleanliness

Poor cleaning can be caused by:

- Cleaning time too short
- Cleaning fluid temperature too low
- Detergent concentration too low
- Detergent not suitable
- Flow rate of the cleaning agent too low (circulation volume too low)
- Contamination by solids
- Plates incorrectly installed
- Pressure too low during cleaning

Contamination by solids

- Plate heat exchangers must always be cleaned manually

If plates have been inserted incorrectly after manual cleaning or a gasket replacement, zones with no flow will be created.

If individual plate groups have insufficient cleaning, check the plate set-up in this area.

If you are not sure, please contact the manufacturer.

To achieve an optimal cleaning result

- Increase the flow rate of the cleaning agent to the maximum (pump at the maximum possible delivery rate)

### 11.1 One-step plan



#### Flushing procedure:

- Clear water
  - until product residues have been rinsed out
- 1.5% sodium hydroxide solution at max. 80°C
  - approx. 30 minutes (max. 45 minutes)
- Clear water
  - until traces of alkali are removed

### 11.2 Two-step plan



#### Flushing procedure:

- Clear water
    - until product residues have been rinsed out
  - 1.5% sodium hydroxide solution at max. 80°C
    - approx. 30 minutes (max. 45 minutes)
  - Clear water
    - until traces of alkali are removed
  - 0.5% nitric acid or 1% phosphoric acid at max. 50°C
    - Max. 20 minutes
  - Clear water
    - until traces of acid are removed
- If daily acid treatment is not possible:
- Recommended frequency of every 7 days (important for hard tap water)

Only use other cleaning agents after consultation with the manufacturer.

#### **Never use cleaning agents with free chlorine ions!**

Prefer liquid detergent over washing powder, especially if

- the homogenisers and
- separator are cleaned.

When cleaning please follow

- recommendations from the detergent manufacturer regarding cleaning plate heat exchangers
- the manufacturer's instructions for the heat exchanger

**ATTENTION: All alkalis and acids used must be disposed of in accordance with local regulations!**

## 12. MAINTENANCE / INSPECTION



### Regularly check:

- the temperature
- the pressure drops and pressure difference (increasing pressure drop -> plates contaminated)
- constant conditions (no pressure fluctuations)
- the tightness of the gaskets
- leakage of the medium
- clamping bolts and nuts
- the clamping dimension
- the entire frame for any defects

### Clamping bolts and threaded spindle:

Make sure that:

- Clamping bolts (in the frame version with clamping bolt lock) and
- the threaded spindle (with frame with central closure frame) are always well-greased.

Recommended: FISCHER special grease

### Retightening the plate heat exchanger

The clamping dimension is the dimension between the frame and the pressure plate (measured from the side of the plate pack). I.e. the dimension of the plate pack.

This dimension should not be lower than the specified final clamping dimension. If medium escapes between the individual plates of the heat exchanger, it may be necessary to retighten the heat exchanger (see also point 9)

### Retightening process:

- Remove the locknut (12a)
- Retighten all nuts for clamping bolts (12) clockwise
- Observe the following
  - Tighten the nuts for the clamping bolts (12) crosswise
  - Parallelism between frame plate (4) and movable pressure plate (10)
  - Clamping dimension according to the type plate (between min. and max.)

If the minimum clamping dimension according to the type plate is reached and the heat exchanger is still leaking, the gaskets must be replaced.

Please note in accordance with point 14 whether there is any other error.

## 13. GASKET REPLACEMENT

Most of the gaskets used are in one or two parts and tailored precisely to the respective type heat exchanger plate.

Gaskets for the starter-plate ( old designation : end plate) can also consist of several parts be.

It must be ensured that all leakage openings remain free!

### 13.1 Glued in rubber gaskets

#### Remove the plates

- Remove the locknuts (12a)
- Unscrew the clamping bolt nuts (12) from the clamping bolt (1)
- Remove the clamping bolt washers (13)
- Remove the clamping bolts (1)
- Push the movable pressure plate (10) away from the plate pack
- Tilt out the first heat exchanger plates downwards 20 - 30cm lengthways [1]
- Tilt the plate out sideways at an

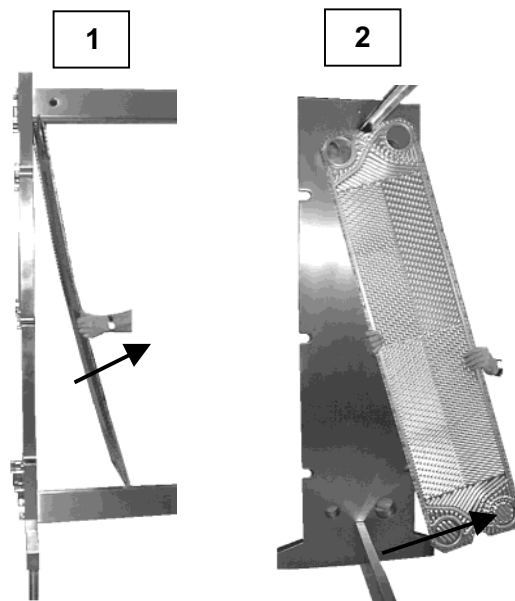

angle of 30 - 45° [2]

- Now remove the plate from the frame
- Remove plate by plate in this way
- Please note the order and installation position of the plates - these must be installed again after cleaning (plates are numbered above)

### Remove old gaskets

- Put the plates in
  - 8% sodium hydroxide solution at about 20°C



**(note the safety information on the use of dangerous substances in point 2)**

- for 8-10 hours
- Remove the gaskets
- Remove adhesive residue thoroughly (possibly by carefully scraping it out with a scraper-like tool)
- Rinse the plates well
- If necessary, clean the plates with a suitable cleaning solution

### Glue in the new gaskets

- Degrease the grooves using one of the following means
  - light benzine
  - Adhesive cleaner
  - acetone
  - toluene
  - ketone
  - spirit

#### **The following must not be used**

- degreasing agents containing chlorine (can damage the plate material)

**(note the safety information on the use of dangerous substances in point 2)**

- Make sure the gaskets are
  - free of grease and
  - dust.
- Coat with FISCHER special glue
  - Grooving the plates
  - Gaskets on the underside (adhesive side)
- Let the glue dry for about 5 minutes
- First, insert the gasket at the two head ends (top and bottom) and press it lightly
- Then lightly press on the side gasketing parts

### Assembly

- Put the cleaned plates back in. Observe:
  - the original order and position of the individual plates (according to numbering and arrangement drawing)
  - gaskets have been inserted and in order
- Hook in the individual plates (swivel in sideways at an angle of 30 - 45°)

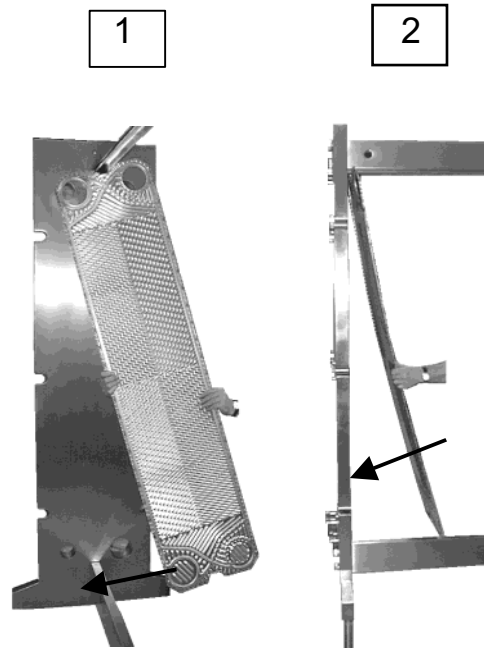

- Push the movable pressure plate (10) to the plate pack
- Put the clamping bolts (1) back into the holes provided or hang them in the side slots
- Place the clamping bolt washers (13) onto the clamping bolt (1)
- Tighten the plate pack with the clamping bolt nuts (12)
  - evenly
  - crosswise
  - Observe the parallelism between the movable pressure plate (10) and the frame plate (4)
- Observe the clamping dimension on the type plate/circuit diagram
- Fix the clamping bolt nuts (12) by screwing on the locking nuts (12a)
- Reconnect the pipes
- For maximum adhesive strength before commissioning
  - Pump hot water (approx. 90°C)
  - through the plate heat exchanger for 2 to 3 hours.
- Commission the heat exchanger according to point 6

### 13.2 "PIN CLIP" rubber gaskets

#### Remove the plates

- Remove the locknuts (12a)
- Unscrew the clamping bolt nuts (12) from the clamping bolt (1)
- Remove the clamping bolt washers (13)
- Remove the clamping bolts (1)
- Push the movable pressure plate (10) away from the plate pack
- Tilt out the first heat exchanger plates downwards 20 - 30cm lengthways [1]
- Tilt the plate out sideways at an

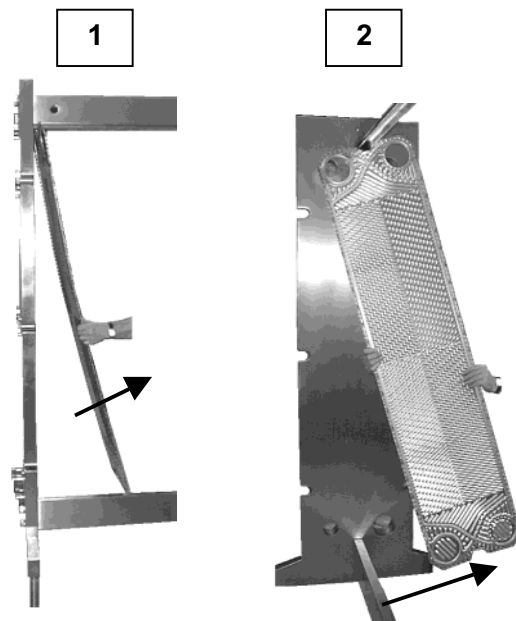

angle of 30 - 45° [2]

- Now remove the plate from the frame
- Remove plate by plate in this way
- Please note the order and installation position of the plates - these must be installed again in the same way



### Remove old gaskets

- Carefully pull the rubber gasket out of the groove
- If necessary, clean the plates with a suitable cleaning solution

#### The following must not be used

- degreasing agents containing chlorine (can damage the plate material)

### Push in the new gaskets

- Place the new gaskets in the gasket groove

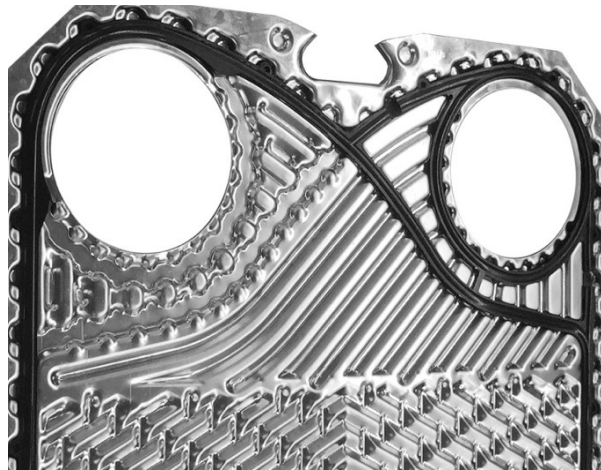

- Position the gasket so that the nubs (for attaching the gasket) lie exactly over the openings in the gasket groove



- Gently push the gasket into the recess with your finger or with a blunt object



- The fixing rubber studs must protrude on the back of the plate.

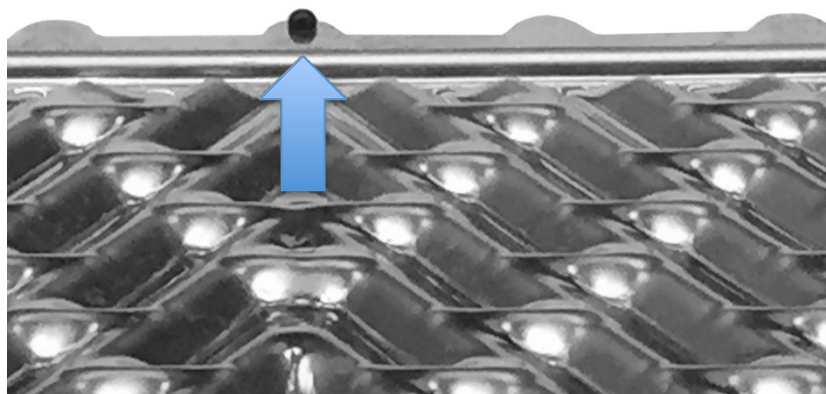

- Make sure that the gasket (plate) is in the correct position during assembly

## Assembly

- Put the cleaned plates back in. Observe:
  - the original order and position of the individual plates (according to numbering and arrangement drawing)
  - gaskets have been inserted and in order
- Hook in the individual plates (swivel in sideways at an angle of 30 - 45°)

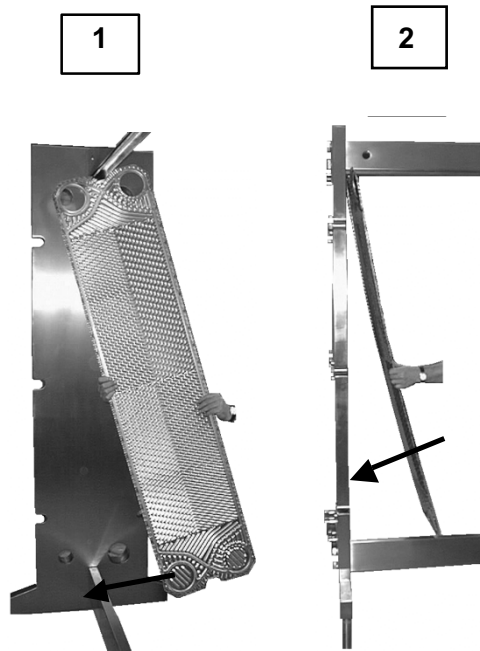

- Push the movable pressure plate (10) to the plate pack
  - Put the clamping bolts (1) back into the holes provided or hang them in the side slots
  - Place the clamping bolt washers (13) onto the clamping bolt (1)
  - Tighten the plate pack with the clamping bolt nuts (12)
    - evenly
    - crosswise
    - Observe the parallelism between the movable pressure plate (10) and the frame plate (4)
  - Observe the clamping dimension on the type plate/circuit diagram
- 
- Reconnect the pipes
  - Fix the clamping bolt nuts (12) by screwing on the locking nuts (12a)
  - Commission the heat exchanger according to point 6

### 13.3 "PRESS IN" rubber gaskets

#### Remove the plates

- Remove the locknuts (12a)
- Unscrew the clamping bolt nuts (12) from the clamping bolt (1)
- Remove the clamping bolt washers (13)
- Remove the clamping bolts (1)
- Push the movable pressure plate (10) away from the plate pack
- Tilt out the first heat exchanger plates downwards 20 - 30cm lengthways [1]
- Tilt the plate out sideways at an

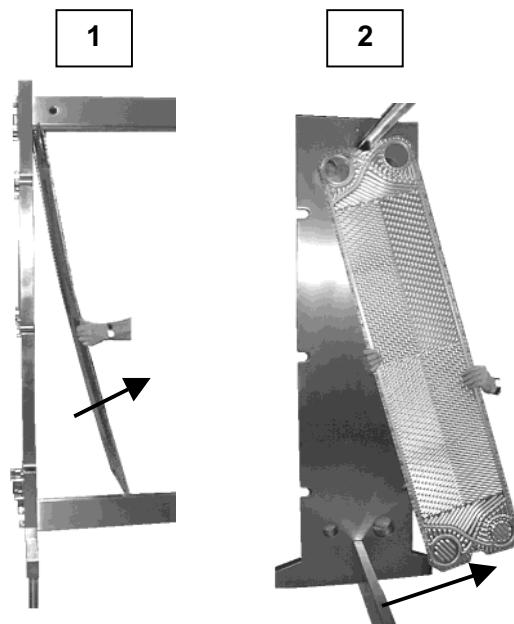

angle of 30 - 45° [2]

- Now remove the plate from the frame
- Remove plate by plate in this way
- Please note the order and installation position of the plates - these must be installed again in the same way

### Remove old gaskets

- Carefully pull the rubber gasket out of the groove
- If necessary, clean the plates with a suitable cleaning solution

#### The following must not be used

- degreasing agents containing chlorine (can damage the plate material)

### Push in the new gaskets

- Mount the new gaskets flush with
  - glycerine or
  - liquid soap
- Press the gasket into the recessed groove (possibly with the help of a blunt screwdriver or similar)
- First, press the gasket in at the head ends (top and bottom)
- Then push the gasket in sideways

The excess lengths of the gaskets must not be cut off.

### Assembly

- Put the cleaned plates back in. Observe:
  - the original order and position of the individual plates (according to numbering and arrangement drawing)
  - gaskets have been inserted and in order
- Hook in the individual plates (swivel in sideways at an angle of 30 - 45°)

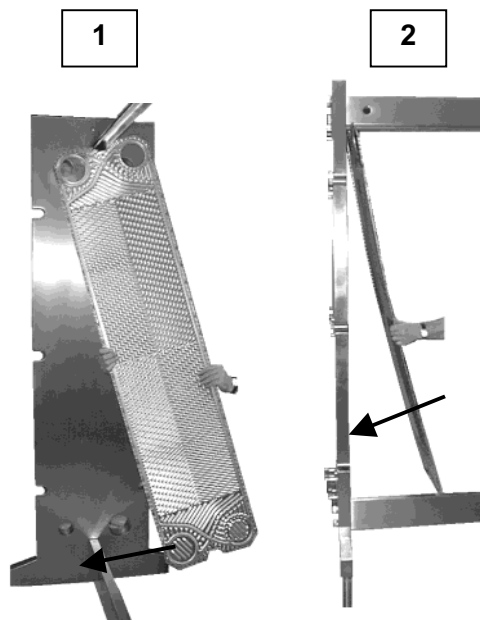

- Push the movable pressure plate (10) to the plate pack
- Put the clamping bolts (1) back into the holes provided or hang them in the side slots



- Place the clamping bolt washers (13) onto the clamping bolt (1)
- Tighten the plate pack with the clamping bolt nuts (12)
  - evenly
  - crosswise
  - Observe the parallelism between the movable pressure plate (10) and the frame plate (4)
- Observe the clamping dimension on the type plate/circuit diagram
- Reconnect the pipes
- Fix the clamping bolt nuts (12) by screwing on the locking nuts (12a)
- Commission the heat exchanger according to point 6

### 13.4 IT gaskets

#### Remove the plates

- Remove the locknuts (12a)
- Unscrew the clamping bolt nuts (12) from the clamping bolt (1)
- Remove the clamping bolt washers (13)
- Remove the clamping bolts (1)
- Push the movable pressure plate (10) away from the plate pack
- Tilt out the first heat exchanger plates downwards 20 - 30cm lengthways [1]
- Tilt the plate out sideways at an

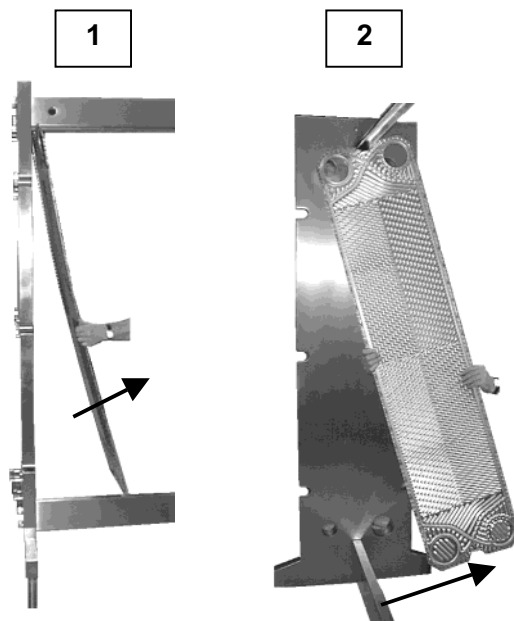

angle of 30 - 45° [2]

- Now remove the plate from the frame
- Remove plate by plate in this way
- Please note the order and installation position of the plates - these must be installed again in the same way

#### Remove old gaskets

- Put the plates in
    - 8% sodium hydroxide solution at about 20°C
- (note the safety information on the use of dangerous substances in point 2)**
- for 8-10 hours



- Remove the gaskets
- Remove adhesive residue thoroughly (possibly by carefully scraping it out with a scraper-like tool)
- Rinse the plates well
- If necessary, subsequently clean the plates with a suitable cleaning solution

**Glue in the new gaskets**

- Degrease the grooves using one of the following means
  - benzine
  - adhesive cleaner
  - acetone
  - toluene
  - ketone
  - spirit

**The following must not be used**

- degreasing agents containing chlorine (can damage the plate material)  
**(note the safety information on the use of dangerous substances in point 2)**
- Make sure the gaskets are
  - free of grease and
  - dust.

**One-piece gaskets:**

- Coat the following with FISCHER special adhesive
  - Entire gasketing groove of the heat exchanger plates
  - Gaskets on the underside (adhesive side)
  - Butt joints of the gaskets
- Let the glue dry for 5 minutes
- First, insert the gasket at the two head ends (top and bottom) and press it lightly
- Then lightly press on the side gasketing parts

The excess lengths of the gaskets must not be cut off. The ends must be pressed together end-to-end!

**Multi-part gaskets**

- Coat the following with FISCHER special adhesive
  - Grooving the plates
  - Upper and lower gasketing parts on the underside (adhesive side)
  - Middle gasketing parts on the underside (adhesive side)
  - Butt joints of the gaskets
- Let the glue dry for about 5 minutes
- First, insert the upper and lower gasketing parts (head ends) into the groove
- Lightly press the inserted gasketing parts
- Then insert the middle gasketing parts into the groove and press them lightly as well
- Stack the plates on top of each other
- Reinstall the plates before the adhesive has hardened
- Then immediately clamp the plate heat exchanger to the required clamping dimension

The excess lengths of the gaskets must not be cut off. The ends must be pressed together end-to-end!



### Assembly

- Put the cleaned plates back in. Observe:
  - the original order and position of the individual plates (according to numbering and arrangement drawing)
  - gaskets have been inserted and in order
- Hook in the individual plates (swivel in at an angle of 30 - 45°)

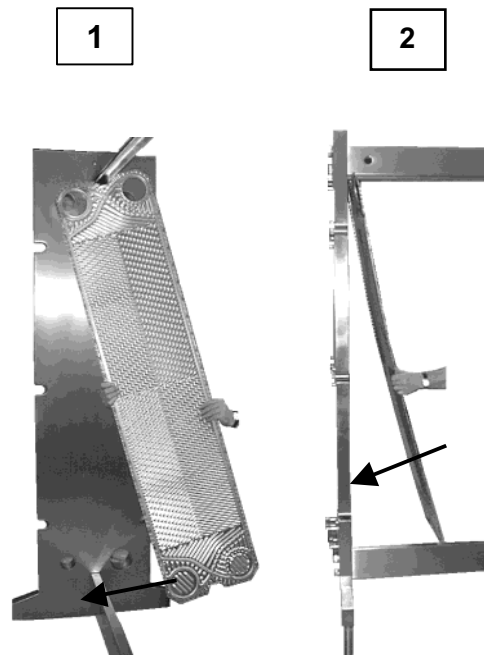

- Push the movable pressure plate (10) to the plate pack
  - Put the clamping bolts (1) back into the holes provided or hang them in the side slots
  - Place the clamping bolt washers (13) onto the clamping bolt (1)
  - Tighten the plate pack with the clamping bolt nuts (12)
    - evenly
    - crosswise
    - Note the parallelism between the movable pressure plate (10) and
  - Observe the clamping dimension on the type plate/circuit diagram
- 
- Fix the clamping bolt nuts (12) by screwing on the locking nuts (12a)
  - Reconnect the pipes
  - For maximum adhesive strength before commissioning
    - Pump hot water (approx. 100°C)
    - through the plate heat exchanger for 2 to 3 hours.
  - Commission the heat exchanger according to point 6

### 13.5 Glued in silicone gaskets

#### Remove the plates

- Remove the locknuts (12a)
- Unscrew the clamping bolt nuts (12) from the clamping bolt (1)
- Remove the clamping bolt washers (13)
- Remove the clamping bolts (1)
- Push the movable pressure plate (10) away from the plate pack
- Tilt out the first heat exchanger plates downwards 20 - 30cm lengthways [1]
- Tilt the plate out sideways at an angle of 30 - 45° [2]

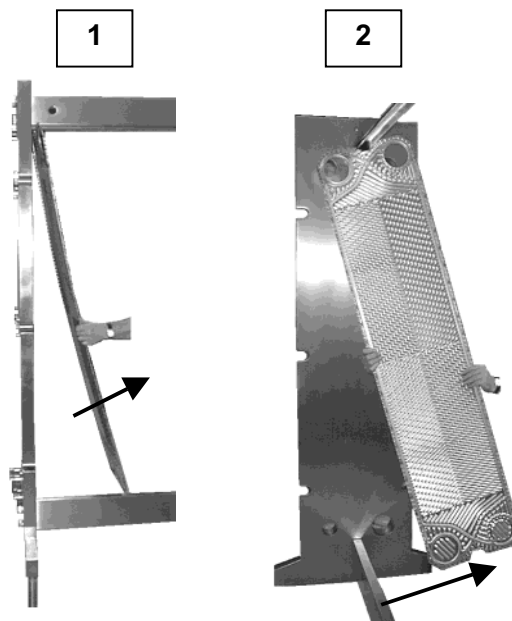

- Now remove the plate from the frame
- Remove plate by plate in this way
- Please note the order and installation position of the plates - these must be installed again in the same way

#### Remove old gaskets

- Remove the gasket with the help of scraper-like tools
- If necessary, subsequently clean the plates with a suitable cleaning solution

### Glue in the new gaskets

- Degrease the grooves using one of the following means
  - benzine
  - Adhesive cleaner
  - acetone
  - toluene
  - ketone
  - spirit



### The following must not be used

- degreasing agents containing chlorine (can damage the plate material)  
**(note the safety information on the use of dangerous substances in point 2)**
- Make sure the gaskets are
  - free of grease and
  - dust.
- Place the first cleaned heat exchange plate in a horizontal position
- Coat the groove of the plate with liquid silicone
- Place the gasket in the groove
- Coat the joints of the gasket with liquid silicone
- Place the next heat exchange plate on the first one
- Glue in the gasket as per the first plate
- Repeat this process until all gaskets are glued in place
- Place a plate slightly larger than the heat exchanger plates on the plate pack
- Weight this plate evenly with approx. 30 kg
- After 6 to 8 hours the plates can be re-assembled in the frame

### Assembly

- Put the cleaned plates back in. Observe:
  - the original order and position of the individual plates (according to numbering and arrangement drawing)
  - gaskets have been inserted and in order
- Hook in the individual plates (swivel in at an angle of 30 - 45°)

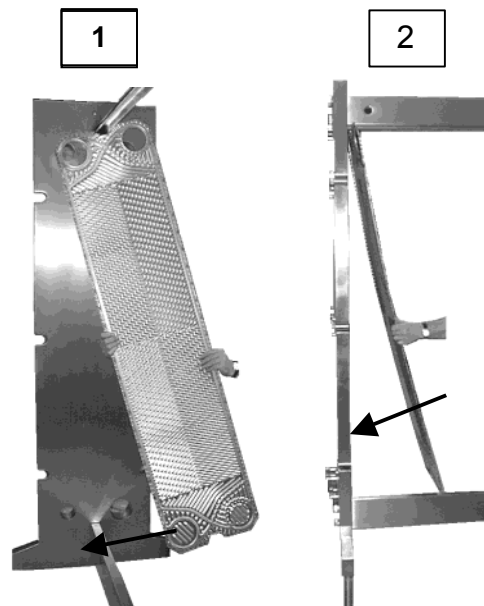

- Push the movable pressure plate (10) to the plate pack
- Put the clamping bolts (1) back into the holes provided or hang them in the side slots
- Place the clamping bolt washers (13) onto the clamping bolt (1)
- Tighten the plate pack with the clamping bolt nuts (12)
  - evenly
  - crosswise
  - Observe the parallelism between the movable pressure plate (10) and the frame plate (4)
- Observe the clamping dimension on the type plate/circuit diagram
  
- Fix the clamping bolt nuts (12) by screwing on the locking nuts (12a)
- Reconnect the pipes
- Commission the heat exchanger according to point 6

# 14 ERROR / CAUSE / REMEDY PLATE HEAT EXCHANGER

Leakage from the heat exchanger	Clamping dimension between min. and max	Clamping to a minimum	Increased pressure drop	Reduced heat transfer	Mixing up the media				Possible cause	Troubleshooting
x	x								Working pressure too high	Reduce the working pressure to the value on the type plate
x	x								Heat exchanger plates not tightened enough	Retighten the plates of the heat exchanger
x	x								Deposits between plates or on gaskets	Disassemble the heat exchanger and clean it by hand
x	x								Deformation of gaskets or plates	Disassemble the heat exchanger and replace deformed parts
x		x							End of life of the gaskets reached	Change gaskets
				x					Coated heat exchanger plates	Manual cleaning or CIP cleaning
			x	x					Coated heat exchanger plates, deposits	Disassemble the heat exchanger and clean it by hand
					x				Broken plate, holes in the plate	Inspection by service technician from Fischer, plate exchange
x									Plate(s) deformed (e.g. over-tightened)	Change plate(s)



---

**15. Drawing, spare parts list**

GESTELLPLATTE

FRAME

CADRE

PLACA DE BASTIDOR

COLONNA PRINCIPALE

РАМА

ANSCHLUSSPLATTE 1

CONNECTION PLATE 1

PLAQUE DE RACCORDEMENT 1

PLACA DE CONEXION 1

PIASTRONE INTERMEDIO 1

РАЗДЕЛИТЕЛЬНАЯ ПЛИТА 1

ANSCHLUSSPLATTE 2

CONNECTION PLATE 2

PLAQUE DE RACCORDEMENT 2

PLACA DE CONEXION 2

PIASTRONE INTERMEDIO 2

РАЗДЕЛИТЕЛЬНАЯ ПЛИТА 2

DRUCKPLATTE

PRESSURE PLATE

PLAQUE DE PRESSION

PLACA DE PRESION

PIASTRA DI PRESSOIO

НАЖИМНАЯ ПЛИТА

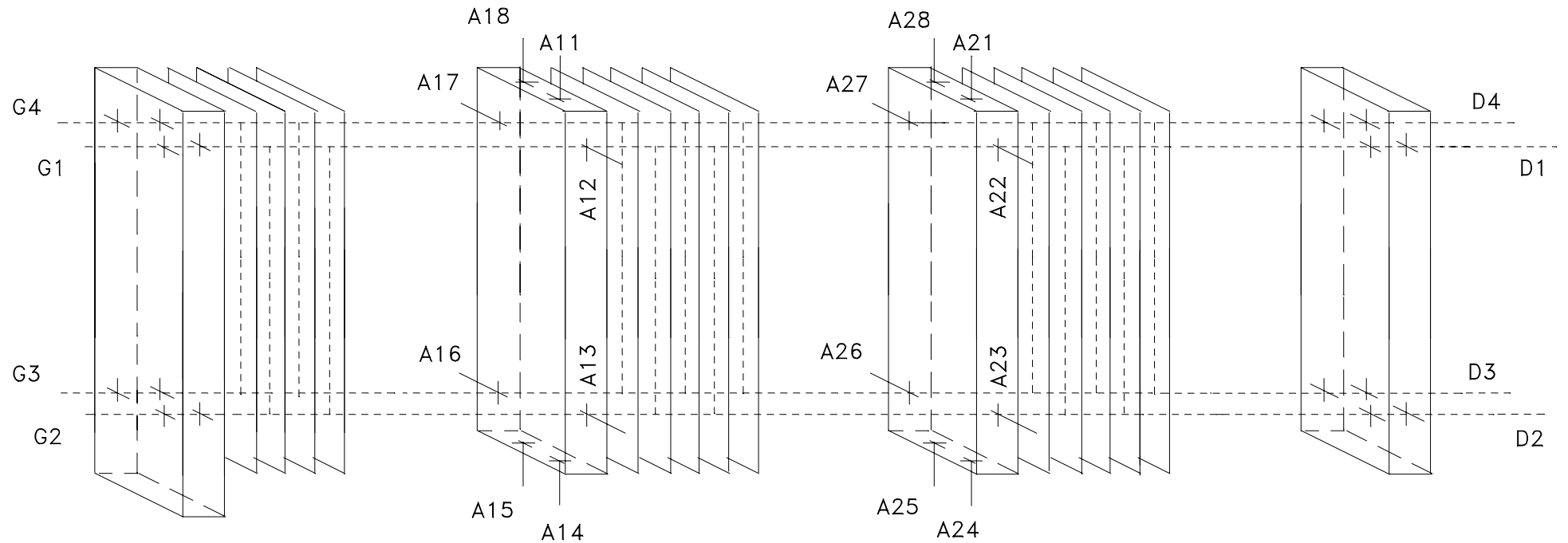

FISCHER

Maschinen- und Apparatebau AG  
Linke Bahnzeile 22  
A-2483 Ebreichsdorf

ANSCHLÜSSE  
CONNECTIONS  
RACCORD  
CONEXIONES  
COINCIDENZA  
ПРИСОЕДИНЕНИЕ

R33

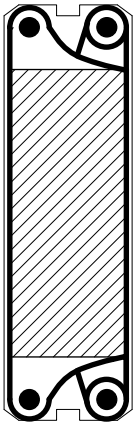

L33

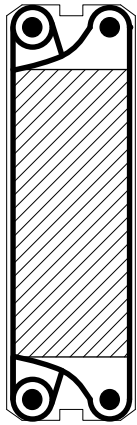

R23

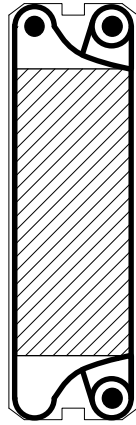

L31

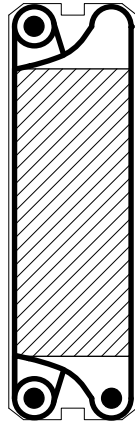

R13

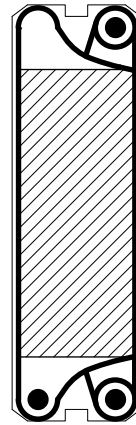

L32

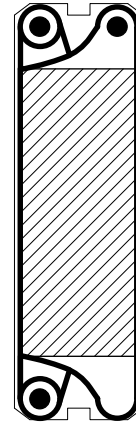

R03

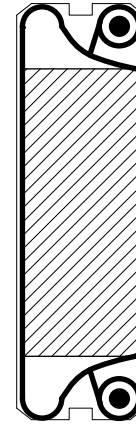

L30

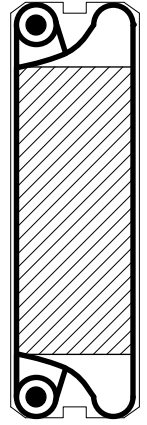

R00

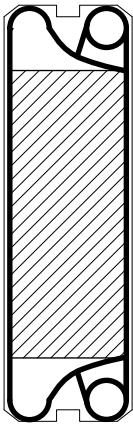

L00

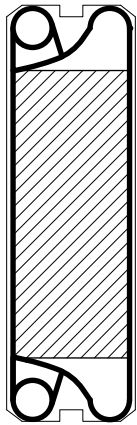

R20

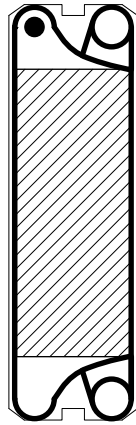

L01

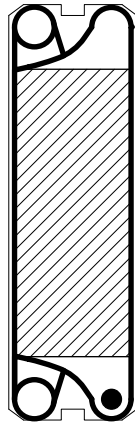

R10

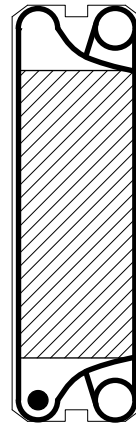

L02

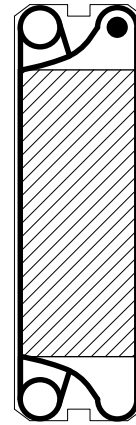

R32

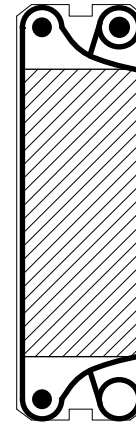

L13

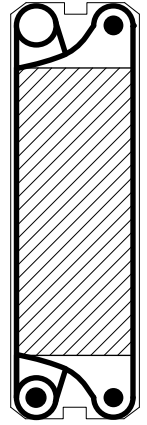



R02

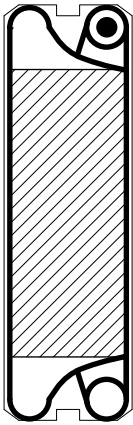

L10

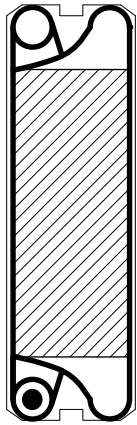

R01

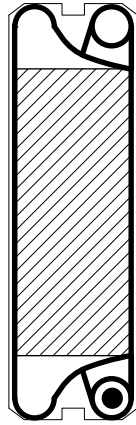

L20

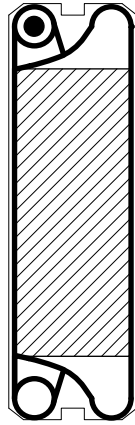

R11

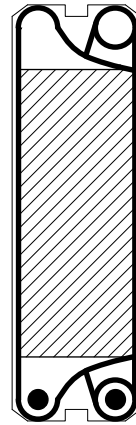

L22

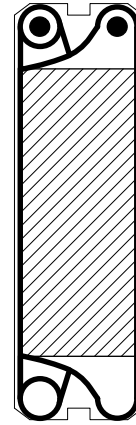

R22

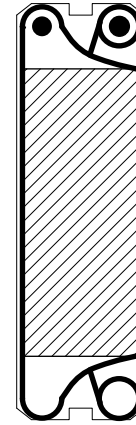

L11

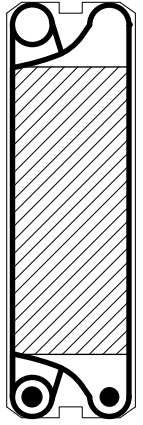

R12

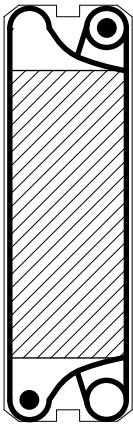

L12

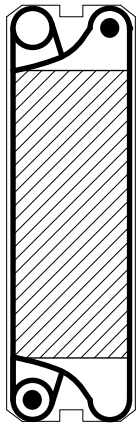

R21

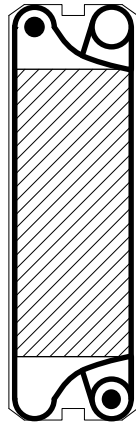

L21

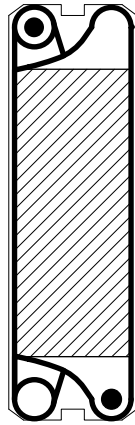

R30

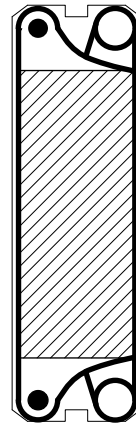

L03

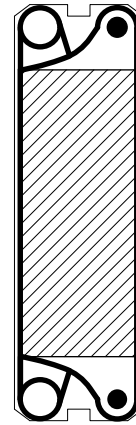

R31

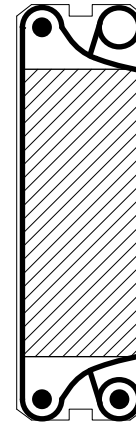

L23

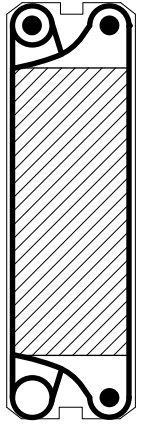

R33a

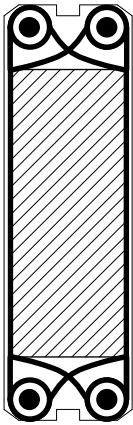

L33a

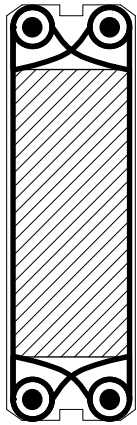

R23a

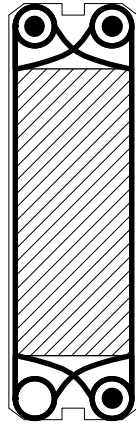

L31a

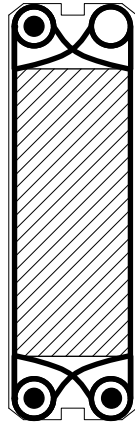

R13a

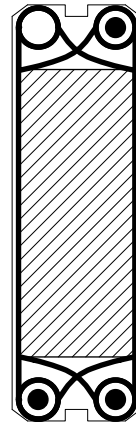

L32a

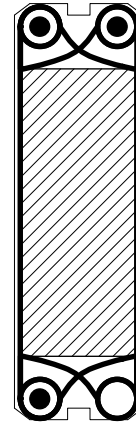

R03a

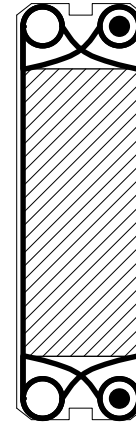

L30a

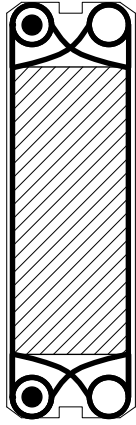

R00a

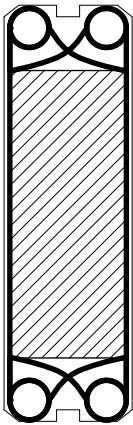

L00a

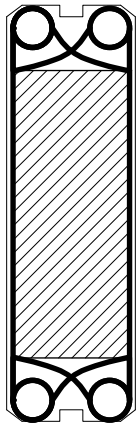

R20a

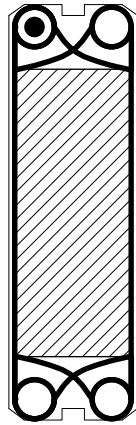

L01a

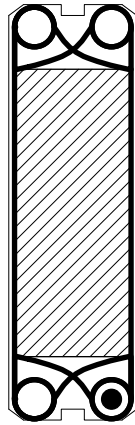

R10a

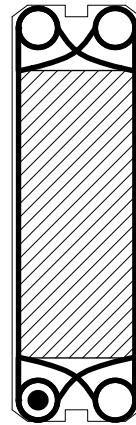

L02a

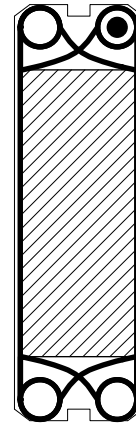

R32a

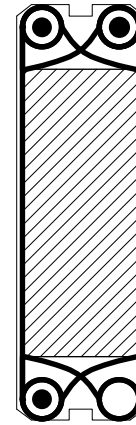

L13a

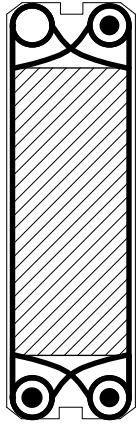

R02a

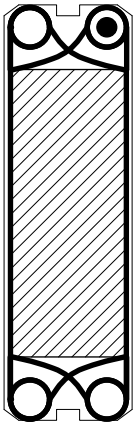

L10a

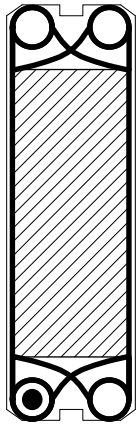

R01a

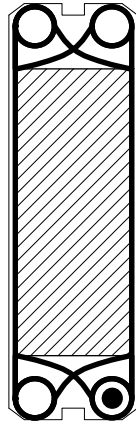

L20a

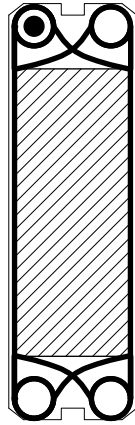

R11a

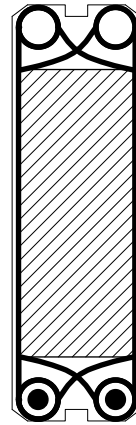

L22a

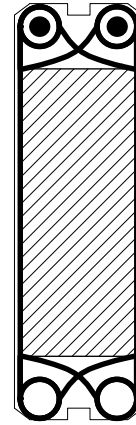

R22a

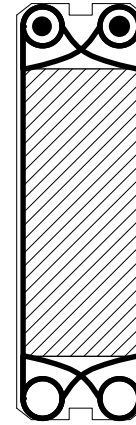

L11a

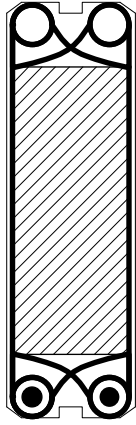

R12a

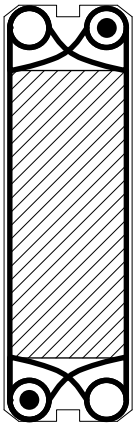

L12a

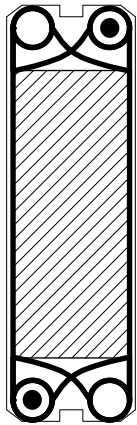

R21a

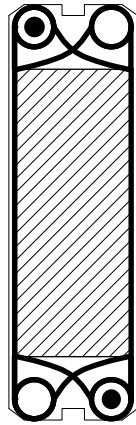

L21a

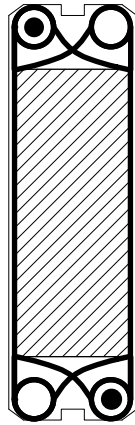

R30a

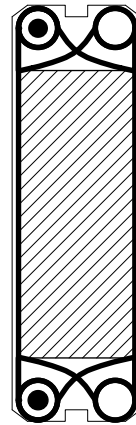

L03a

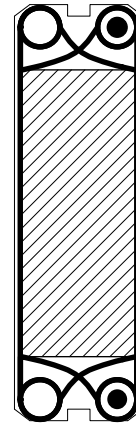

R31a

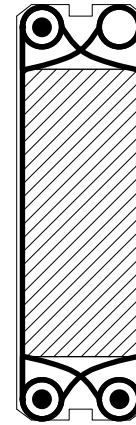

L23a

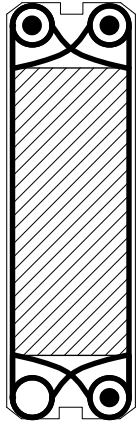

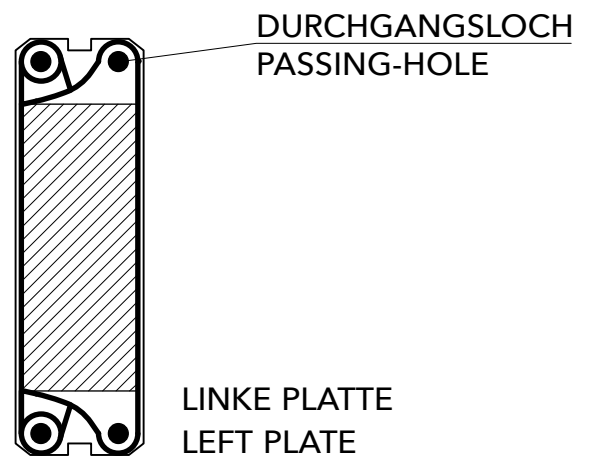
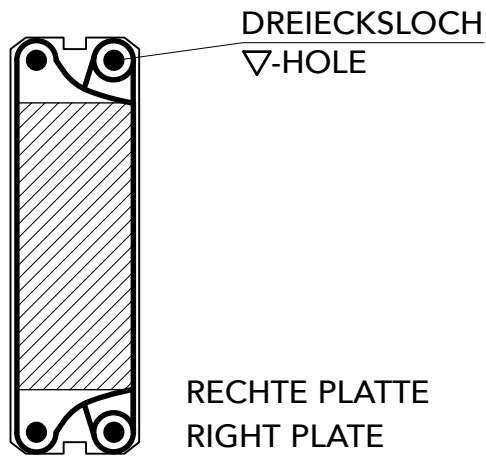

COMBI FLOW - CF

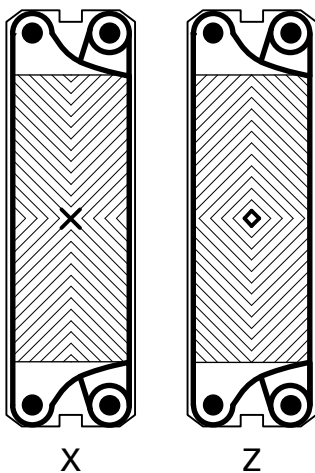

DOUBLE FLOW - DF

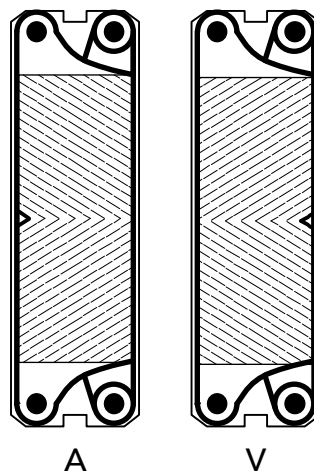

FISCHGRAT

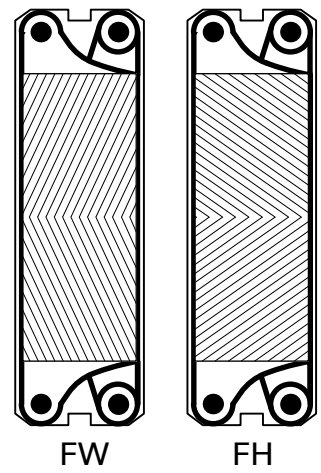

UNIVERSAL  
HARD  
UH

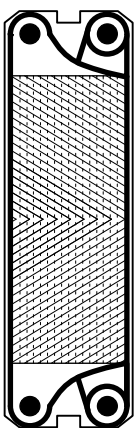

HEISSHALTE  
HEAT HOLDING  
HH

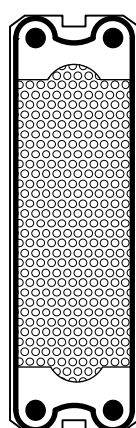

FREISTROM  
FREE FLOW  
FF

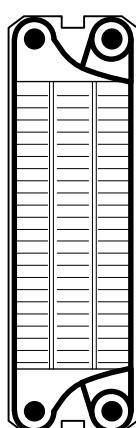

STEAM/PRODUCT  
SP

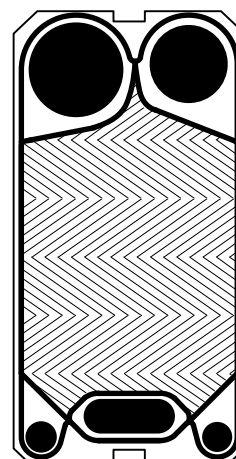

OMNI FLOW  
OF

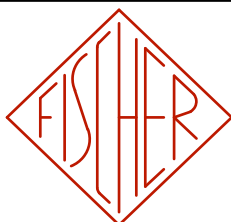
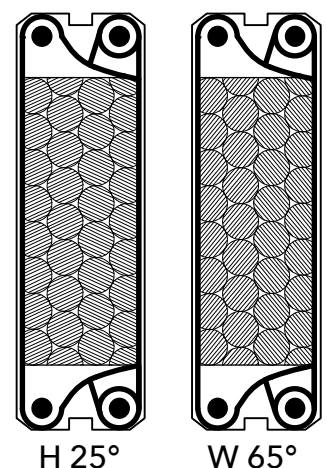

Fischer Maschinen- u. Apparatebau GmbH  
AT-2483 Ebreichsdorf, Linke Bahnzeile 22

WÄRMEAUSTAUSCHPLATTEN  
HEAT EXCHANGE PLATES  
PLAQUES D'ÉCHANGE  
PLACAS INTERCAMBIADORAS DE CALOR  
PIASTRA SCAMBIATRICE DI CALORE

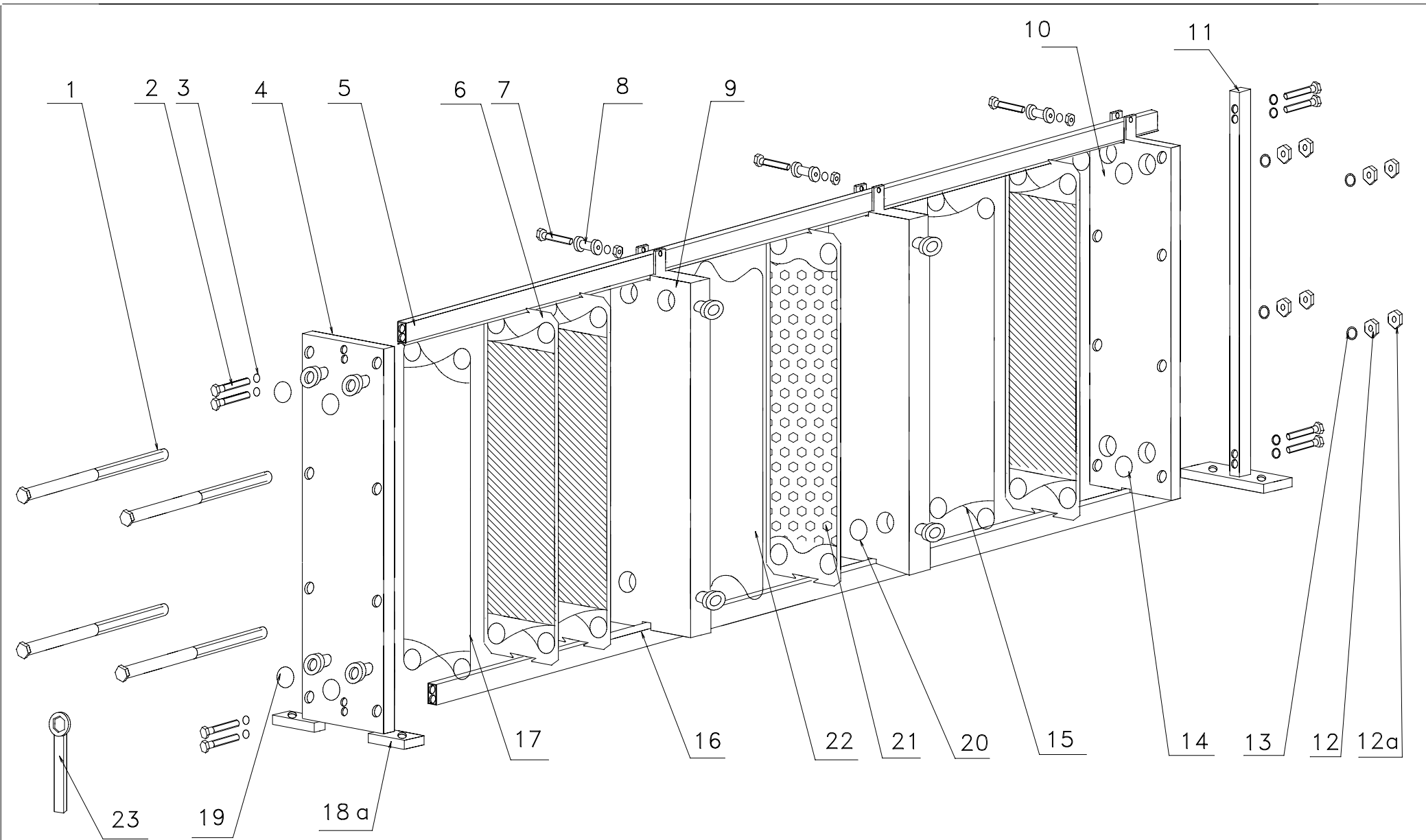

FISCHER

MASCHINEN- UND APPARATEBAU AG

BESTANDTEILLISTE  
 LIST OF ELEMENTS  
 LISTE DE PIÉCES  
 LISTA DE PIÉZAS  
 ELEMENTI  
 СПЕЦИФИКАЦИЯ ДЕТАЛЕЙ



## **Fischer Maschinen- und Apparatebau GmbH**

Linke Bahnzeile 22  
A-2483 Ebreichsdorf  
Austria / Europe

Tel.: +43 / 02254 72212  
Fax: +43 / 02254 73715  
[www.fischer-ag.com](http://www.fischer-ag.com)